

3D MAX BASICS

- Tools
- Modeling
- Materials
- Lighting
- Animating
&
- Rendering Skills

A Beginners Guide

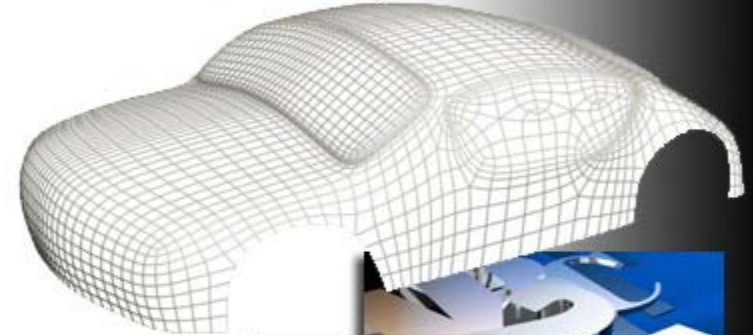

Common Tools

The interface of 3D Max is complex and confusing. Thankfully, there are only a handful of buttons and settings that you need to know to get started.

TWELVE COMMONLY USED COMMANDS, BUTTONS AND PROCEDURES

7. Undo & Redo

2. Transform Tools
 Select & Move
 Select & Rotate*
 Select & Scale
 *Use this tool only if you want rotate an object

4. Modify Panel (Click to modify an object & to see Modify List (Bend, MeshSmooth etc.)

1. Create Panel
 Geometry
 Shapes
 Lights
 Camera

8. Reflect Tool

5. Material Editor
 add textures & colors

12. Quick Render

11. Make Key - Sets the timing of a modifier.

10. Auto Key - Turns on animation mode.

9. Key Filters

3. Zoom - Centers all objects into viewports.

6. Arc Rotate - Spins viewer around object - Use this "only" in the perspective window.



MOUSE/KEYBOARD SKILLS

The mouse is a useful tool when using 3D Max

The Left button is for selecting and transforming (move, rotate, rescale) objects.

Holding down the Left mouse button on a parameter and moving the mouse forward or backward will quickly adjust that parameter.

The Center Roller will allow you move in closer to your scene.

Holding the Center Roller down will let you the viewport frame.



Holding the "Control" key allows you to select more than one object.

6. Arc Rotate - Spins viewer around object - Use this "only" in the perspective window.

Objects

You model stuff and set up scenes in 3D Max using objects.

Objects are found on the "Create" panel

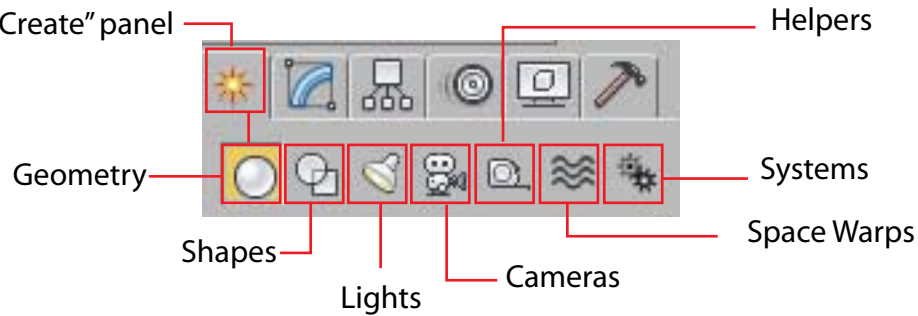

1. Objects used to create models include "Geometry" and "Shapes"

GEOMETRY (Also called "Primitives") objects include: Boxes, Cylinders, Spheres, Cones etc.

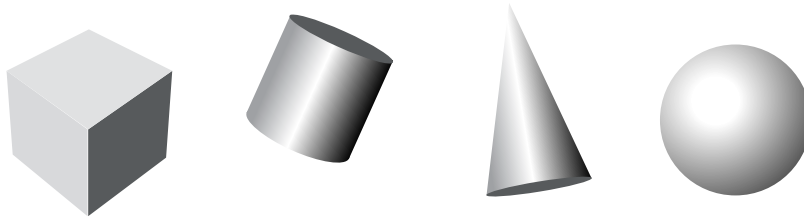

SHAPE objects include: Circles, Rectangles, Lines, Text etc. These shapes can be turned in 3D models using several techniques shown in this booklet.



2. Objects used to set up your scene include "Lights" and Cameras"

CAMERAS

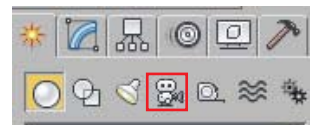

LIGHTS

For our purposes we will use "Standard" lights

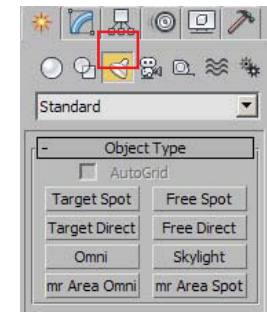

Objects-Primitives

Primitives are basic geometry objects. You can use primitives (and Extended Primitives) to make simple stuff like tables, lamps and even funny characters. Below are some examples of the primitives that come with 3D Max.

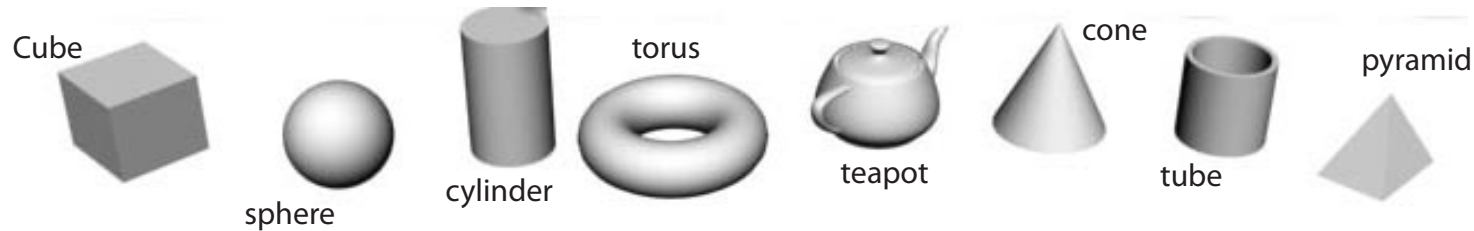

Making a Primitive

Primitives are located on the "Create Panel"

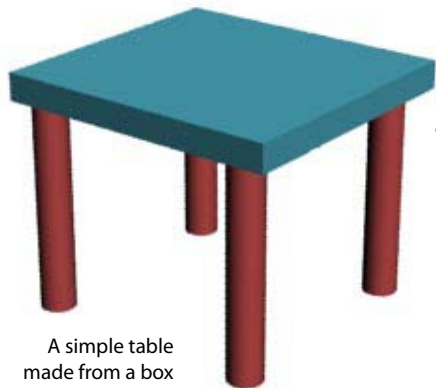

Select "box" and then click in the "Perspective" viewport and first drag the base of the box then release the mouse button and move the mouse upwards to make the height of the box

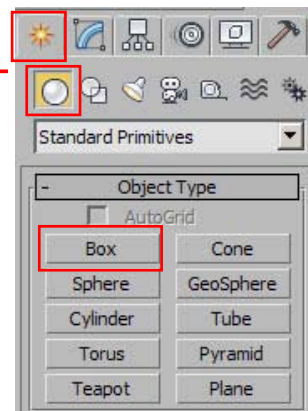

1. Select the "Modify" button.
2. The "parameters" for the box are located under the "Stack"

NOTE:
If you adjust a primitive's parameter while using the "Auto Key" it will record the change and you have then created an animation.

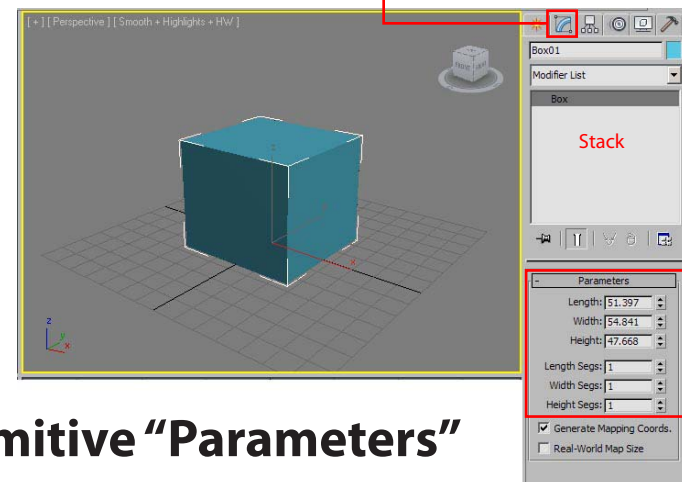

Adjusting Primitive "Parameters"

Modifiers

Modifiers change the shape or behavior of a model. There are dozens of modifiers on the “Modifier List” but in this class we generally use only a handful.

Commonly use modifiers include:

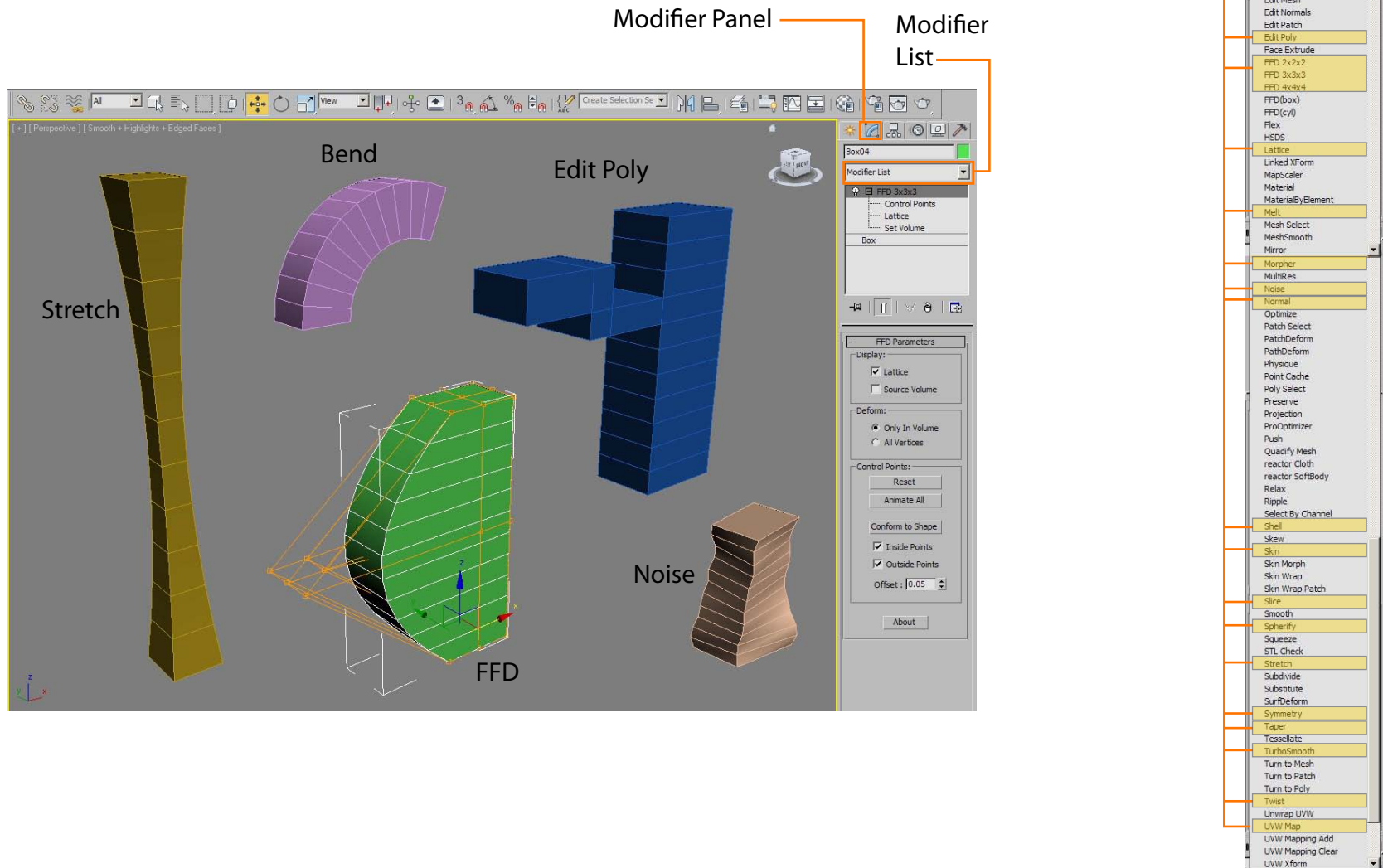

Sub-Object Level

All "Geometry" and "Shapes" (Objects) in 3D Max are made of a combination of sub-object parts. You can place the "Edit Poly" modifier on 3D objects or the "Edit Spline" modifier on 2D objects and access their sub-objects. You may then select and move them to develop your models.

Here are some Sub-Object modeling techniques.

These are the Sub-Objects for a box:

- Vertex
- Edge
- Border
- Polygon
- Element

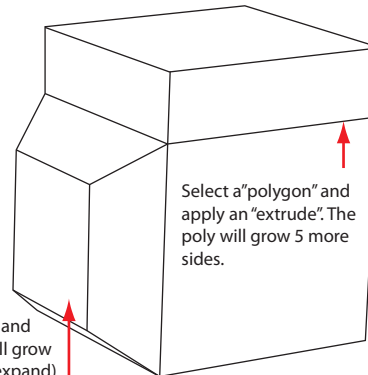
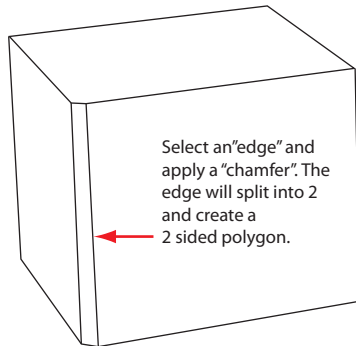
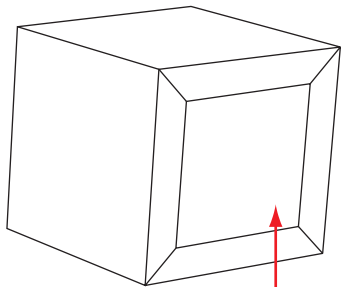
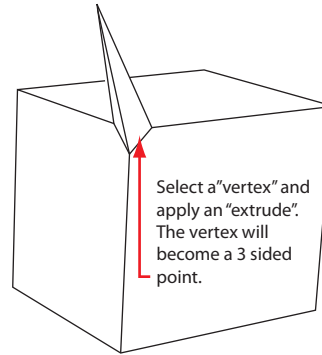
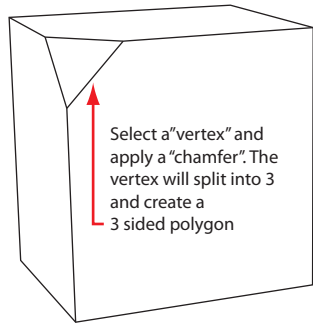

Select a "polygon" and apply an "extrude". The poly will grow 5 more sides.

These are the Sub-Objects for the letter "T". A text shape found in the Shapes panel:

- Vertex
- Segment
- Spline

Select a "Vertex" and reshape the 2D shape.

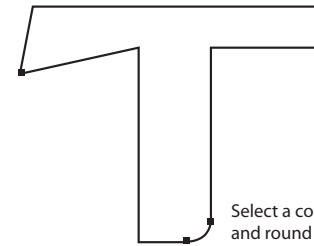

Select a corner "Vertex" and round the corner of with the "Fillet" tool.

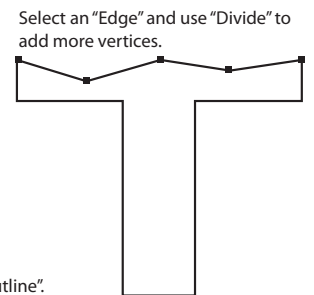

Select the "Spline" and click "Outline".

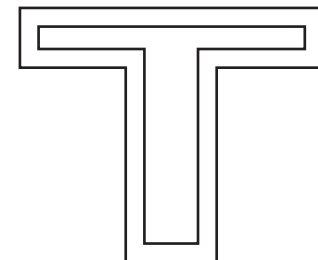

Poly Modeling

Box (Poly) modeling is the most powerful and versatile technique for modeling objects in 3D. Just about anything you can think of can be modeled using this method.

The simplest way to learn Box Modeling is to, well, start with a box. Boxes are found on the "Create" panel, under "Standard Primitives".

Next, apply the "Edit Poly" modifier found on the drop down "Modifier List".

Open the Edit Poly modifier and select "Polygon".

Then select "Extrude".

Finally, click on one of the sides of the cube, hold the mouse button down and move the mouse. A new set of polygons will appear.

Continue clicking sides of the cube to make a more complex shape.

Try the "Bevel" tool. This tool with extrude and resize the face of the polygon.

Experiment with the other tools on the panel.

Use the "Move" tool to move the vertices, Edges & Polygons to sculpt your design.

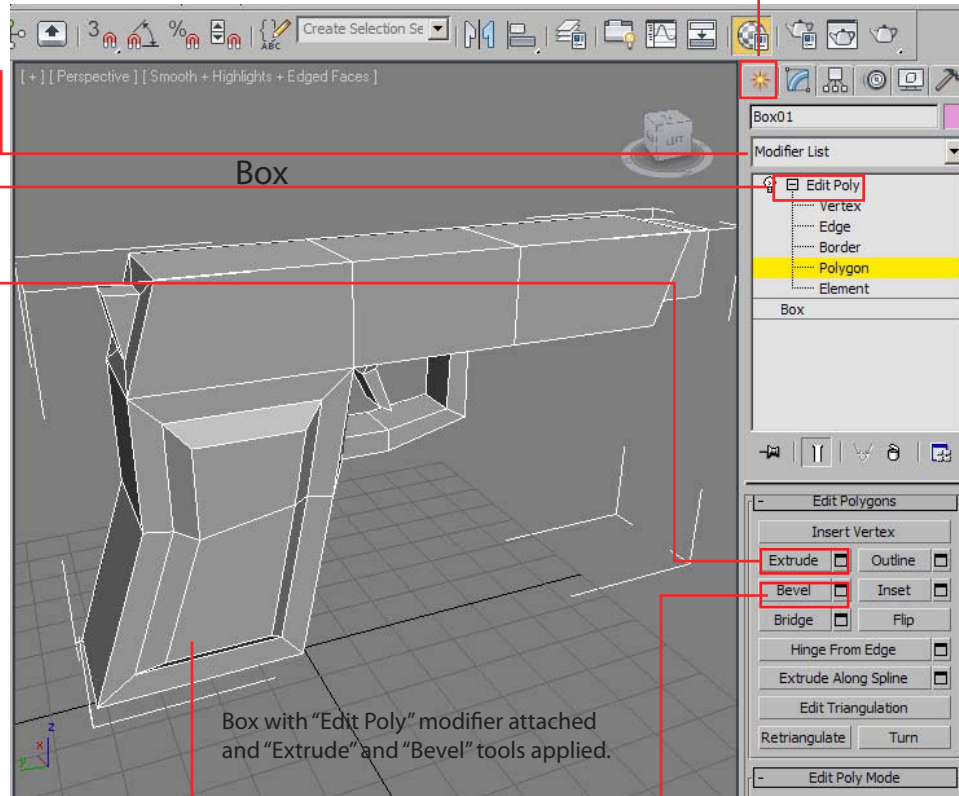

A simple automatic weapon made using the box modeling method

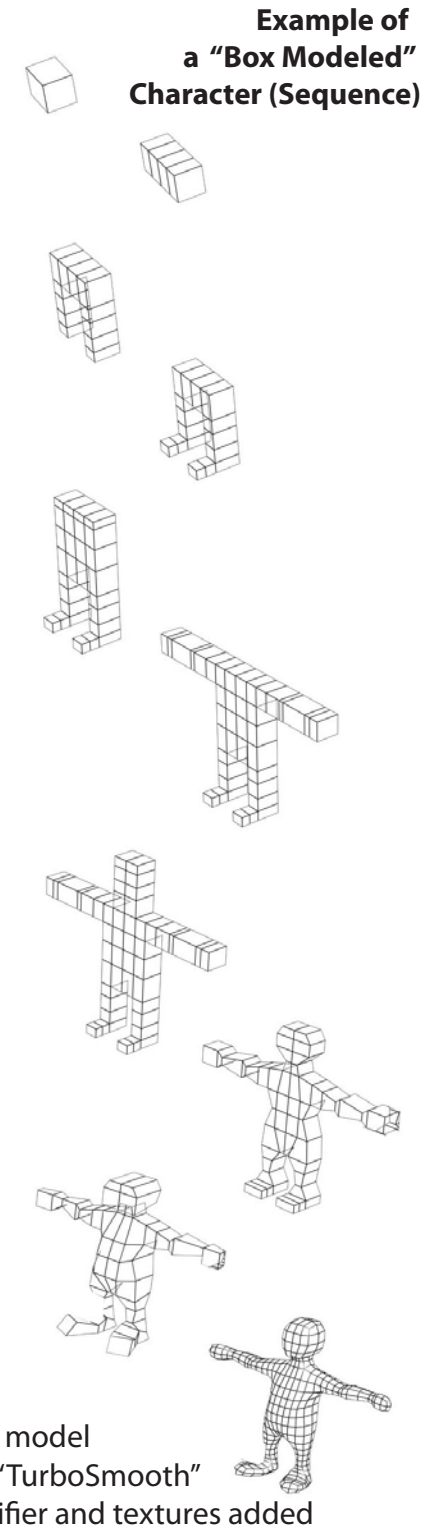

Lathing

Lathing is a modeling technique where a spline (line) is spun around a central axis to create a three dimensional object.

First draw a shape using the "Line" tool.

Next, add the the "Lathe" modifier on top of the Line.

Open the "Axis" to set the proportions of the new 3D object.

Adjust the "Parameters" to refine the shape.

PARAMETERS

Degrees - How far around the line spins.

Weld Core - Removes the "pucker".

Flip Normals - Sometimes the inside needs to be flipped to the outside.

Segments - Smooths the 3D objects.

Capping - Covers holes if you don't set the degrees to 360.

Direction - Which way the line is lathed.
Align - Adjusts the "Axis".

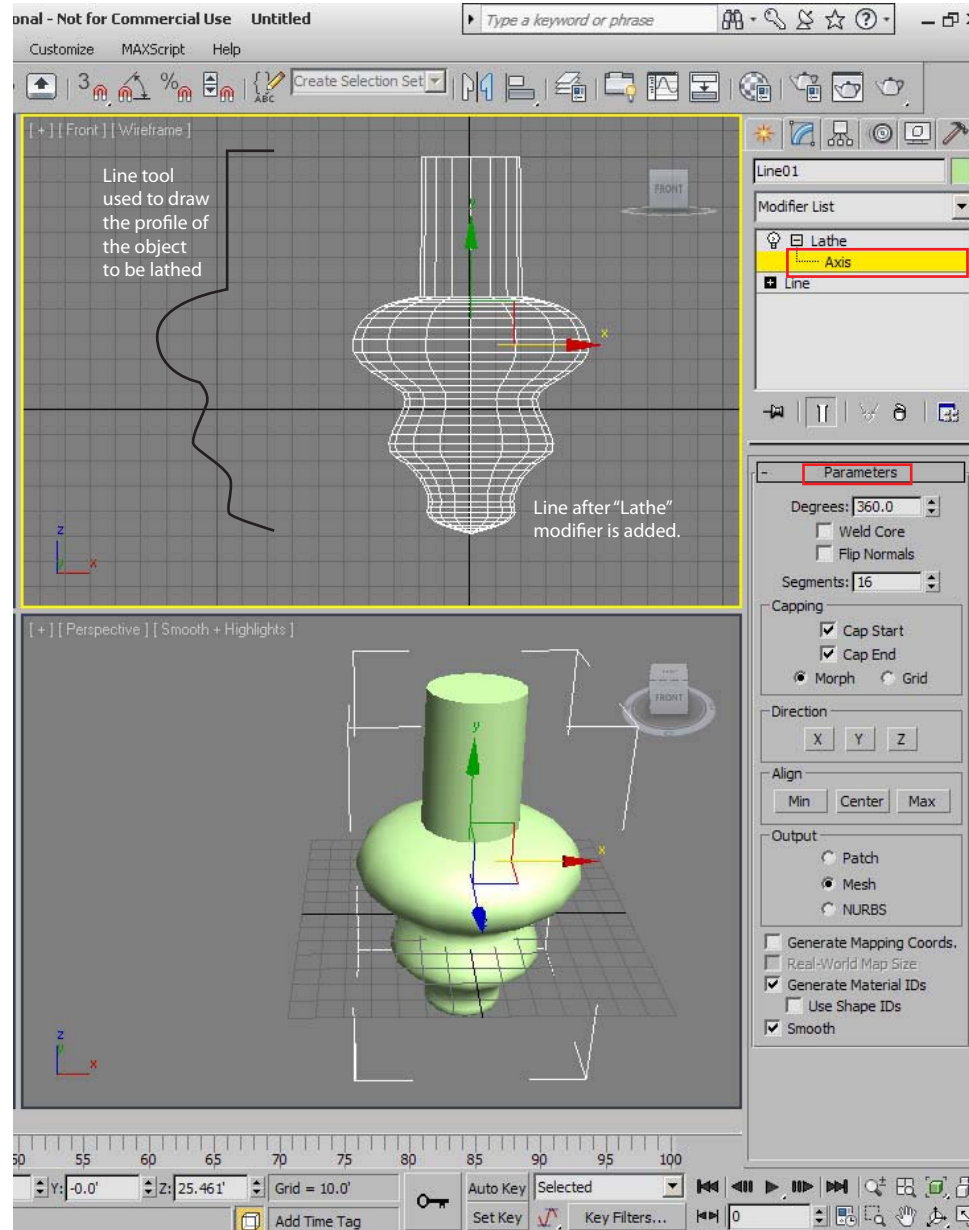

Examples of "Lathed" objects

A baseball bat lathed from a spline

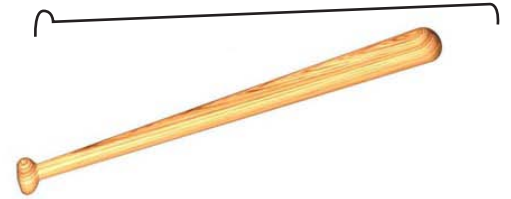

A cup lathed from a spline

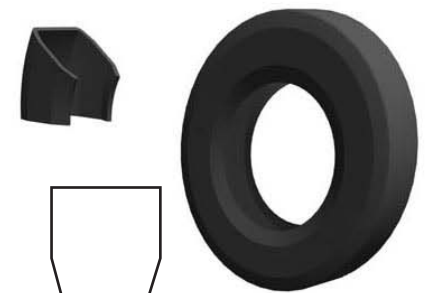
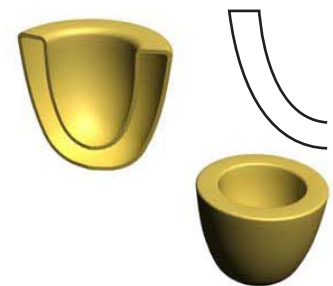

A car tire lathed from a spline.

Extruding

Lathing is a modeling technique where a spline (line) is stretched to create a three dimensional object.

One of the most common spline objects to extrude is text.

First, locate the text tool in the "Shapes" panel.

Type your name or a message.

Drop down the "Modifier List" and select the Extrude modifier.

Adjusted the parameters.

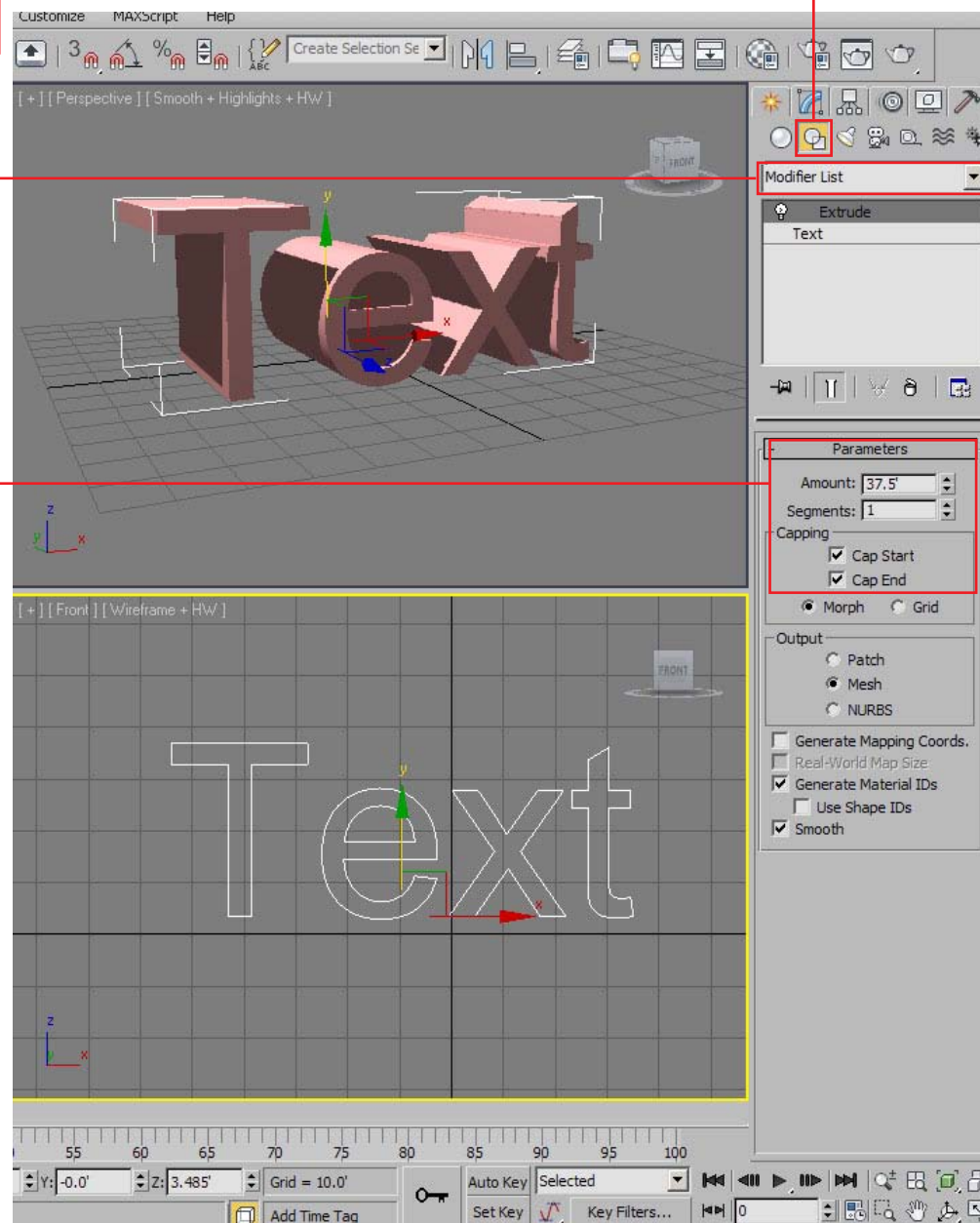

Examples of "Extruded" objects

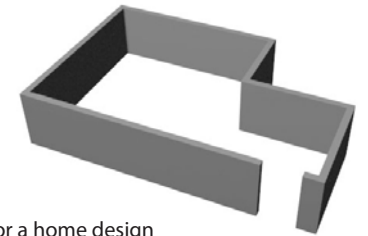

Walls for a home design

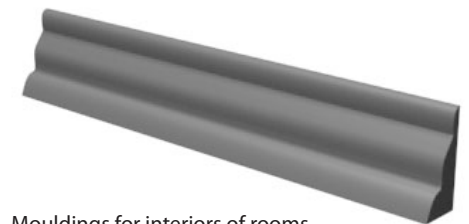

Mouldings for interiors of rooms

Compound Objects: Booleans

Booleans are a way to make two or more objects interact to create a new object. Typically the Boolean process involves "Subtracting" geometry.

1. Begin by making some geometry, let's say a sphere.
2. Next create a tube and then a box.
3. Arrange the three meshes so they intersect
4. Select the Sphere.

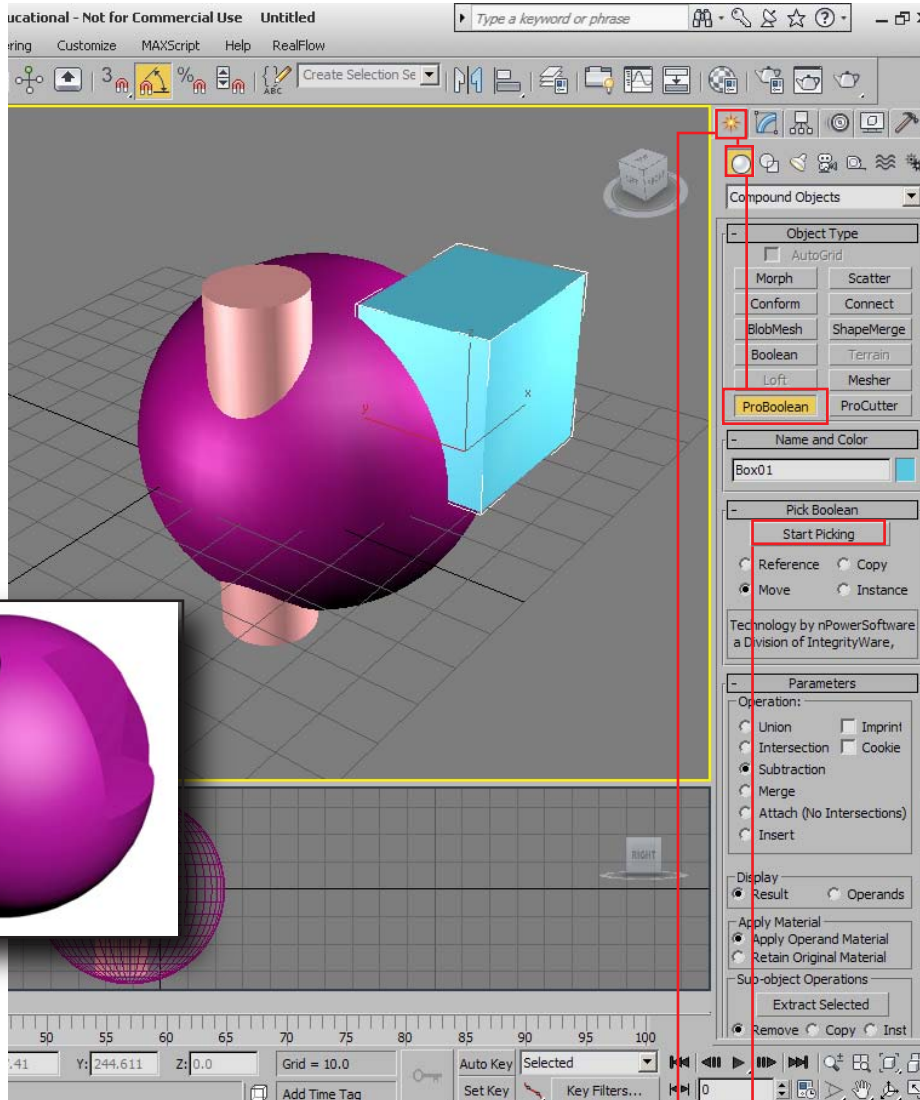
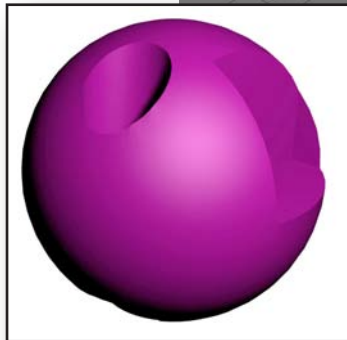

5. Open the "Create" panel and drop the menu to "Compound Objects"
6. Select "ProBoolean".

7. Click the "Start Picking" button select the cylinder and then the box.

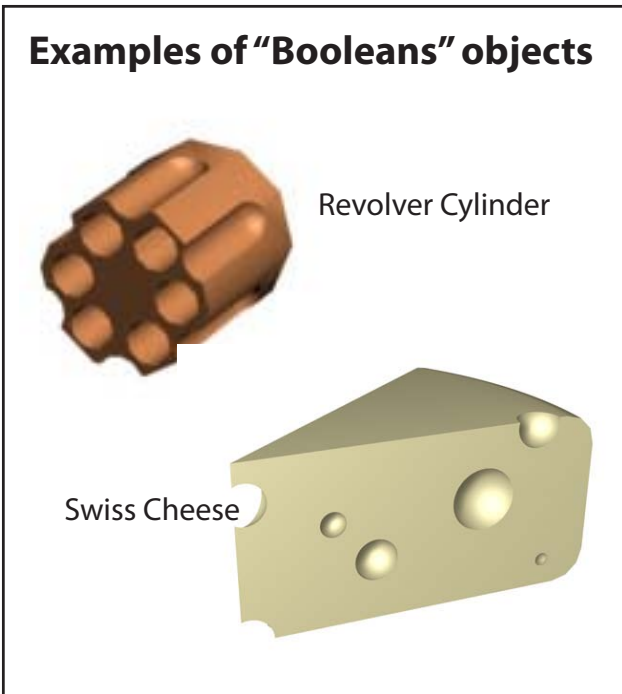

Compound Objects: Lofting

Lofting is a modeling technique where two or more shapes (splines) are stretched and blended along a path.

1. Begin by making 2 shapes and 1 path

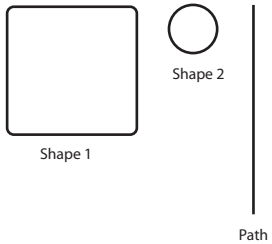

3. Click "Get Shape" button & select Shape 1.

4. Adjust the "Path" to 50%. This makes room for the next shape.

5. Click "Get Shape", again and select Shape 2.

6. Turn off "Display Skin" Button

2. Next, select the path and open "Loft" (Create > Compound Objects > Loft)

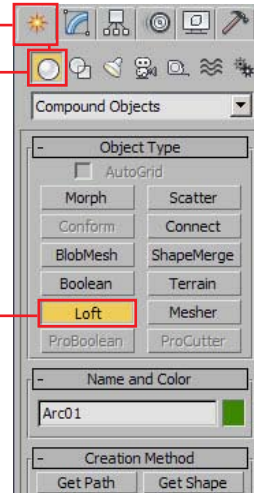
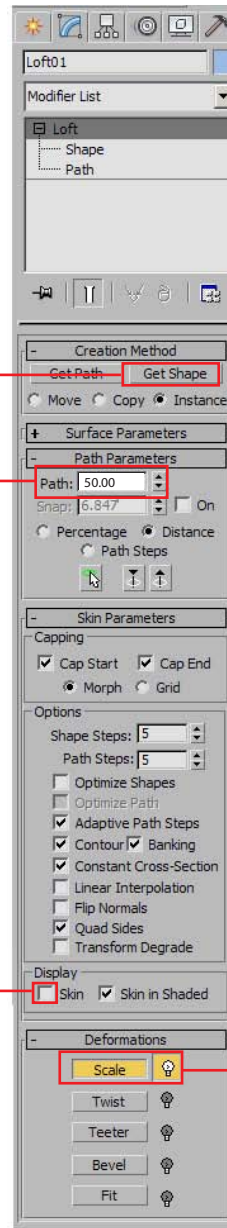

7. By adjusting the Path settings, you can add as many shapes to the path as wanted.

8. Open the "Scale" panel. It is found at the bottom of the Loft panel.

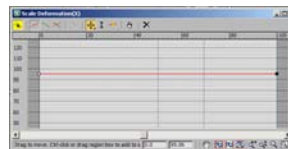

9. By adding "Corner Points" and moving them about, you can model the new 3D object.

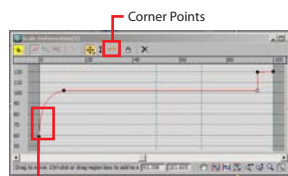

Note: Right click on a Corner Point to turn it into a Bezier Curve.

Examples of "Lofted" objects

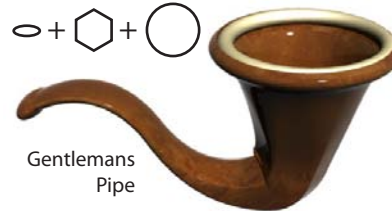
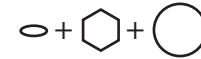

Human Intestine

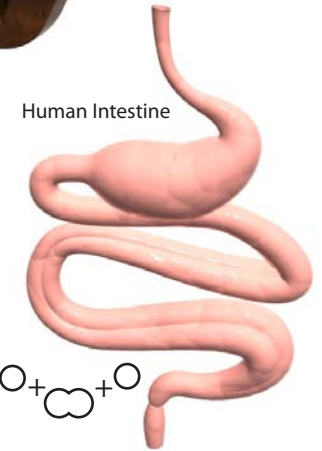
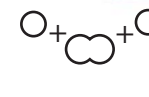

Cameras

Cameras allow you to control the look of your scenes and animations. Just as in real life, 3D Max has a variety of camera types, complete with different lens' and options.

1. The fastest way to set up a camera is to go into the "Perspective" viewport and do rough set up of how you want the scene to be viewed.
2. Go to the "Views" menu and select "Make Camera From Viewport"

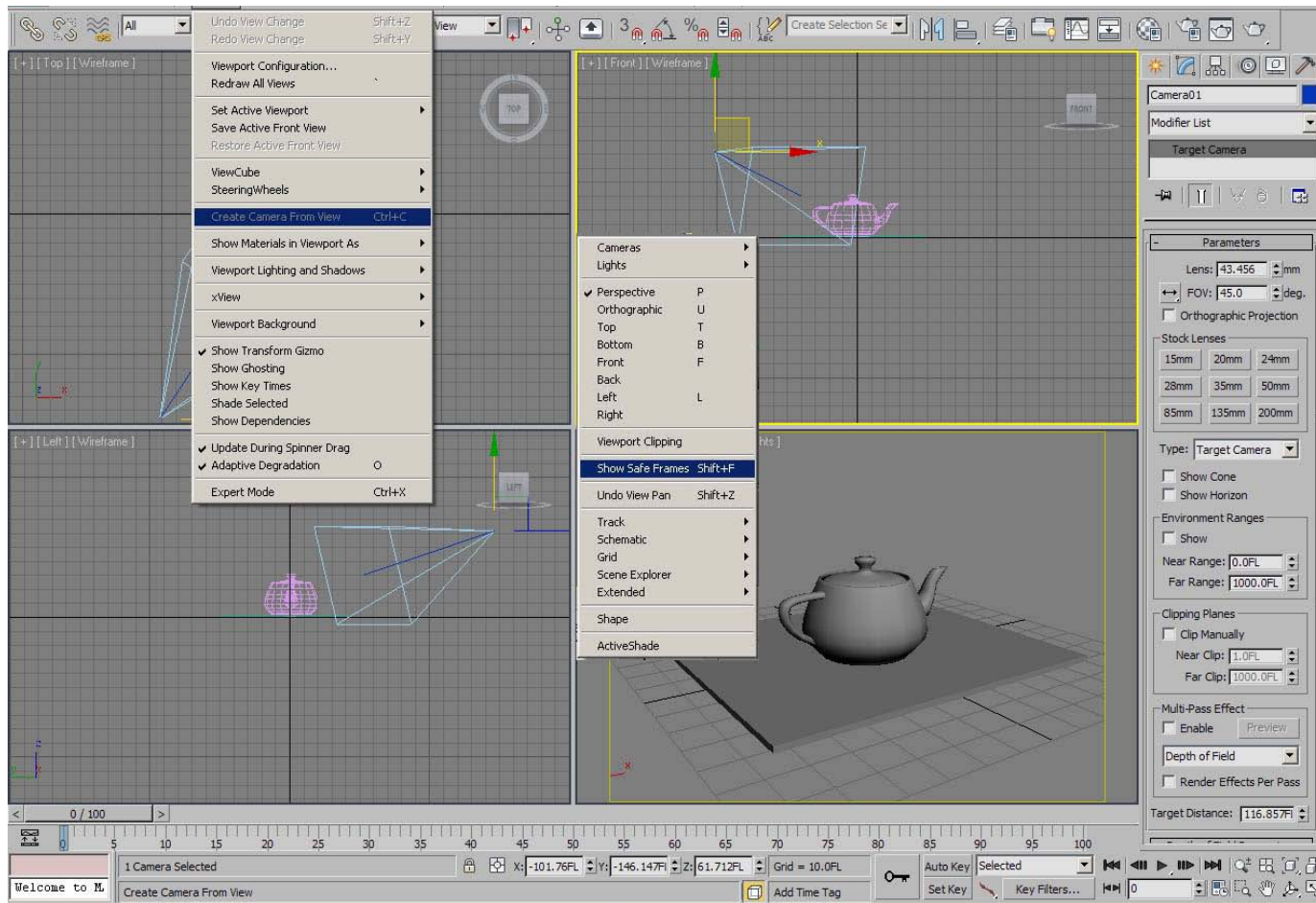

The same scene using three different camera settings

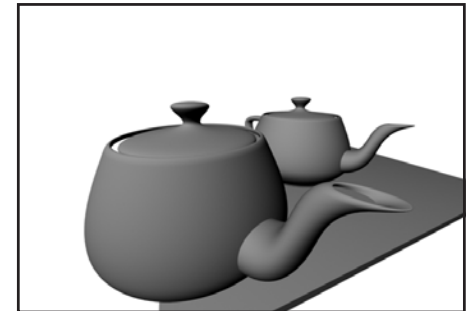

15mm

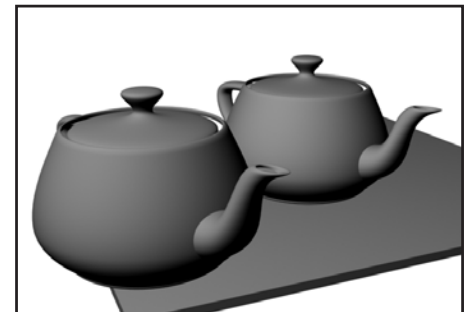

50mm

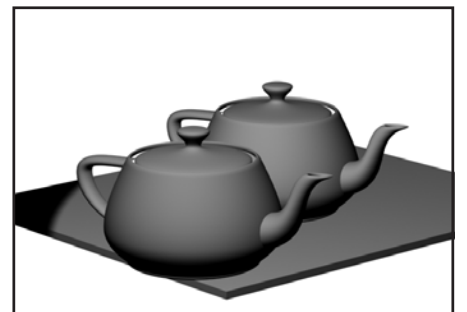

200mm

3. Don't forget to turn on "Show Safe Frames". This shows you the edges of the picture frame.

The camera, like any other object, can be selected and then modified in the "Modify" panel

Lighting: Basics

Lighting scenes for films or video games is an enormous job requiring specially trained artists. These are some simple tips to learn basic lighting.

To practice, set up a simple scene with a plane and a teapot

Use a "Standard" style light. It's easy to set up and adjust.

Then, select a "Target Spot".

In the "Front Viewport", click and drag the light from above the teapot, to below the teapot. As in the diagram below.

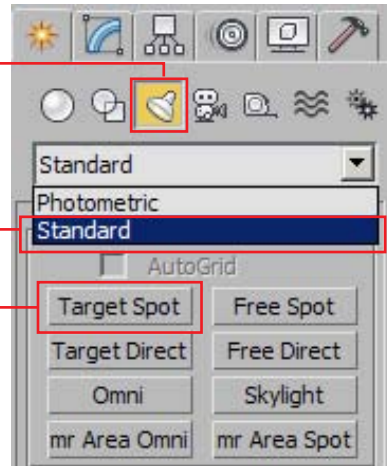

Set the parameters to match those below.

Next, turn on the settings in the "Perspective Viewport" to match those in the diagram below.

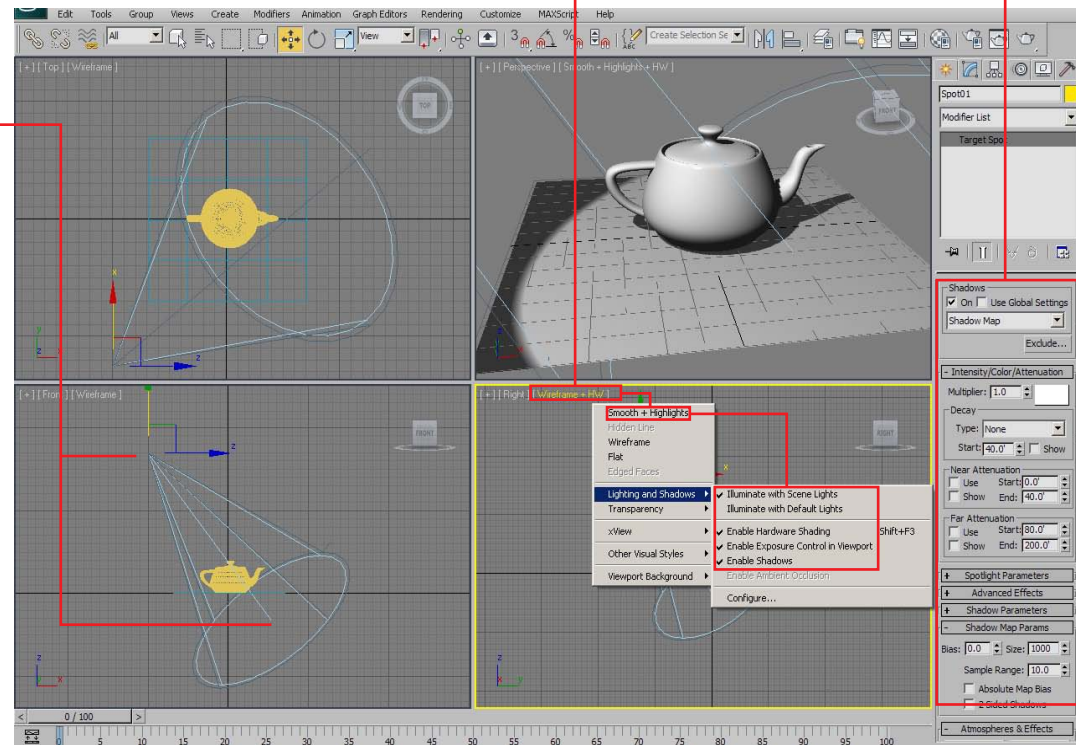

Lighting: Presentation

When you present your animation for review/grades you'll need to use more than one light. To get the best effect a "High Key" light and a "Low Fill" light should be used. The Key light is the main light for the scene. The Fill light lightens the dark side of your models.

To practice, set up a simple scene with a plane and a teapot and the two lights.

The "High Key" light is placed above and in front of the primary object in the scene. Make sure that its "Shadow" button is turned on.

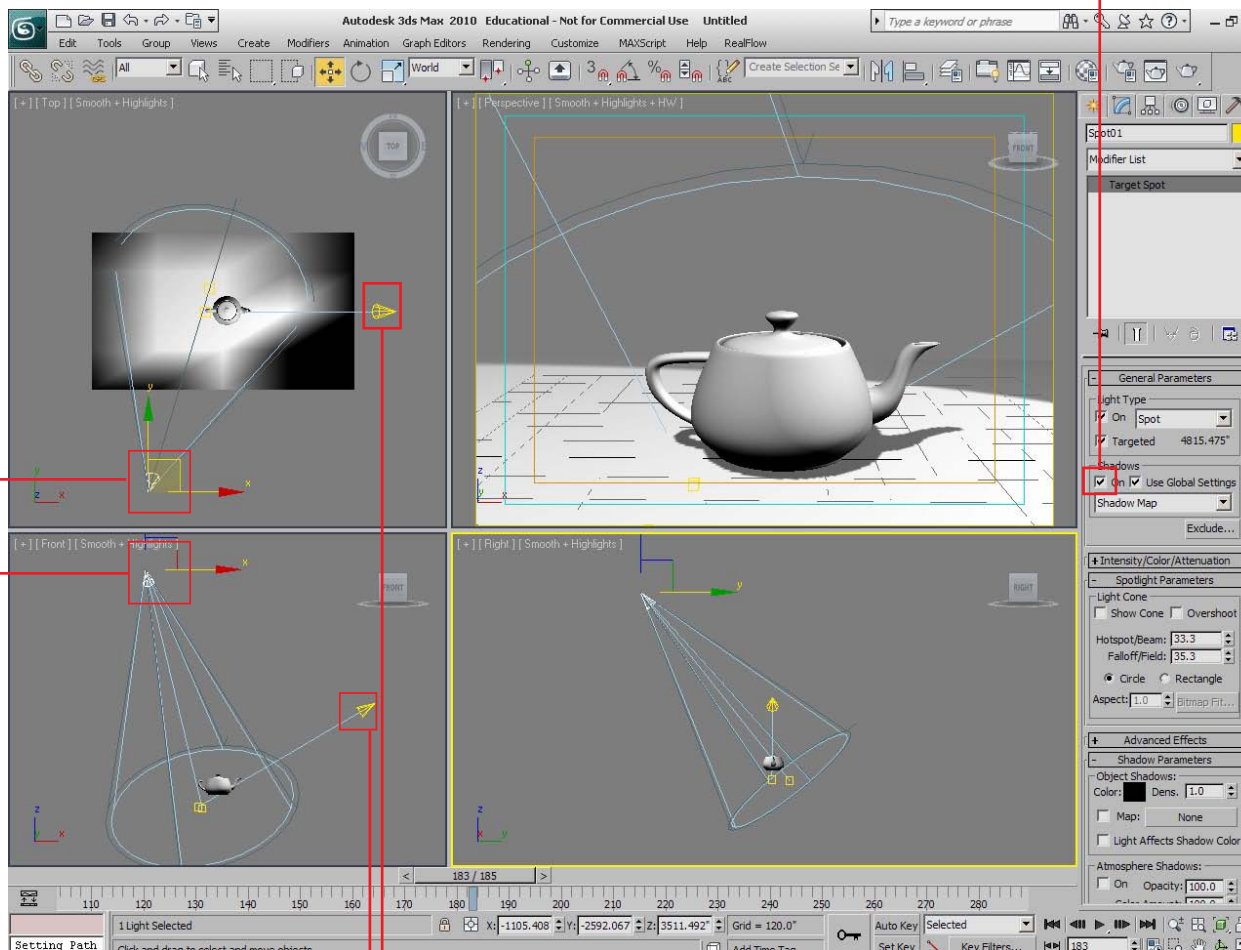

The "Low Fill" light is to the side of the primary object. Turn its "Shadow" on only if it makes the scene look better.

Materials: Color

Applying a material to your model can be simple or complex, it depends on the model and what you want to do. This is simple way to color texture a model.

The "Material Editor" is open by clicking this button

Select a material sphere and drag it to your model.

Always add a "UVW Map" modifier.

Get in the habit of naming your textures

Change the color by clicking here.

Adjust the surface shine with these two parameters.

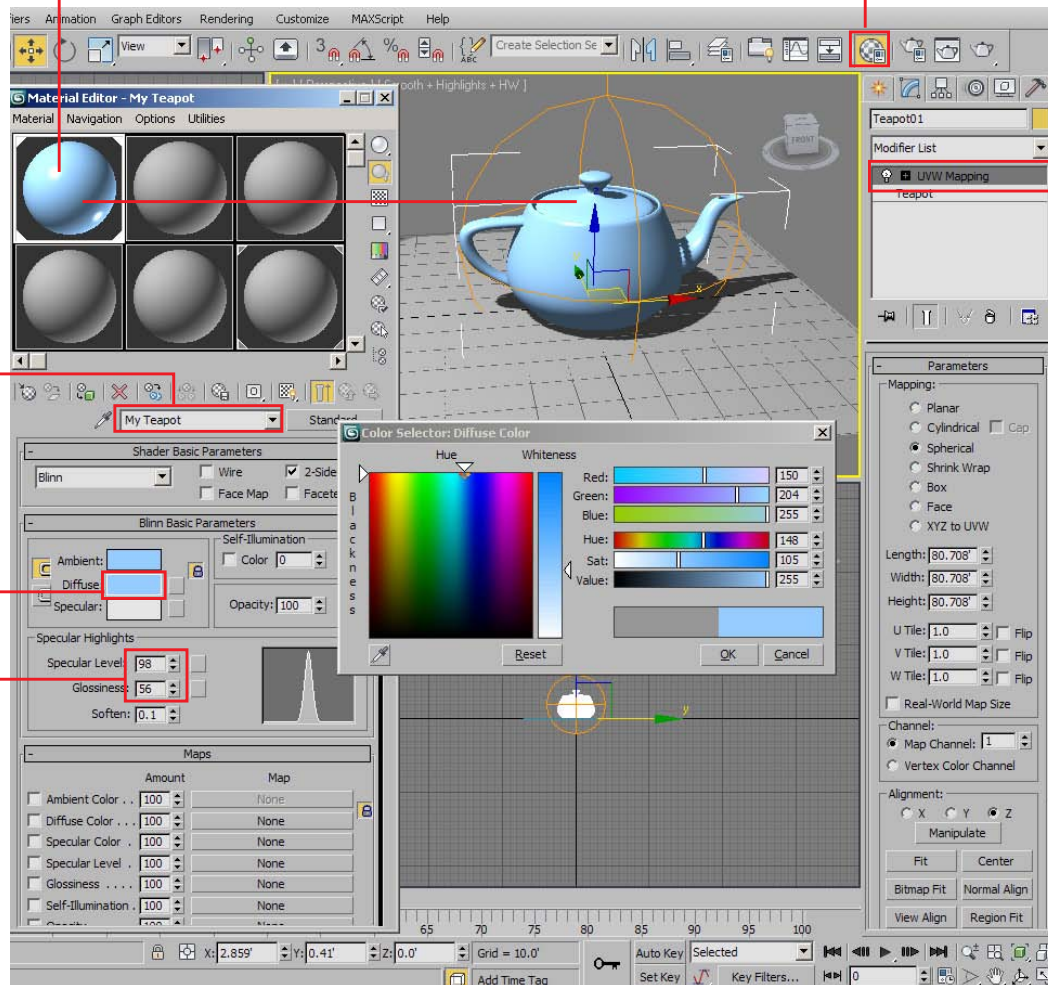

Materials: Bump Maps

A bump map is a texture that makes the surface of your model look bumpy... or dimensional. Bump maps are simple black and white images. Where the image is black it will make the model look sunken. Where it is white, the model surface will stick out.

3D Max comes with some premade bump maps like "Noise" and "Cellular".

Or...

You can make your own bump maps using PhotoShop and/or Illustrator.

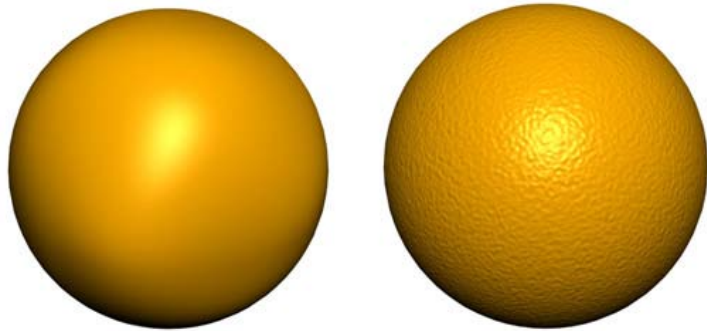

An orange without a bump map and with the 3D Max "Noise" bump map.

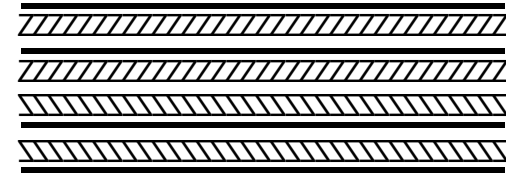

This tire tread design was made in Adobe Illustrator then saved as a JPEG. It was then applied to a tire made in 3D Max using the "lathing" technique.



Materials: JPEG Maps

A JPEG is just a file name for a photograph that is stored in your computer. In this case you're going to wrap a photograph of some wood around your model.

1. Click here. Select "Bitmap". Then find the photo you want to use.

2. Select a material sphere and drag it to your model.

The "Material Editor" is opened by clicking this button.

Always add a "UVW Map" modifier.

Get in the habit of naming your textures.

Adjust the surface shine with these two parameters.

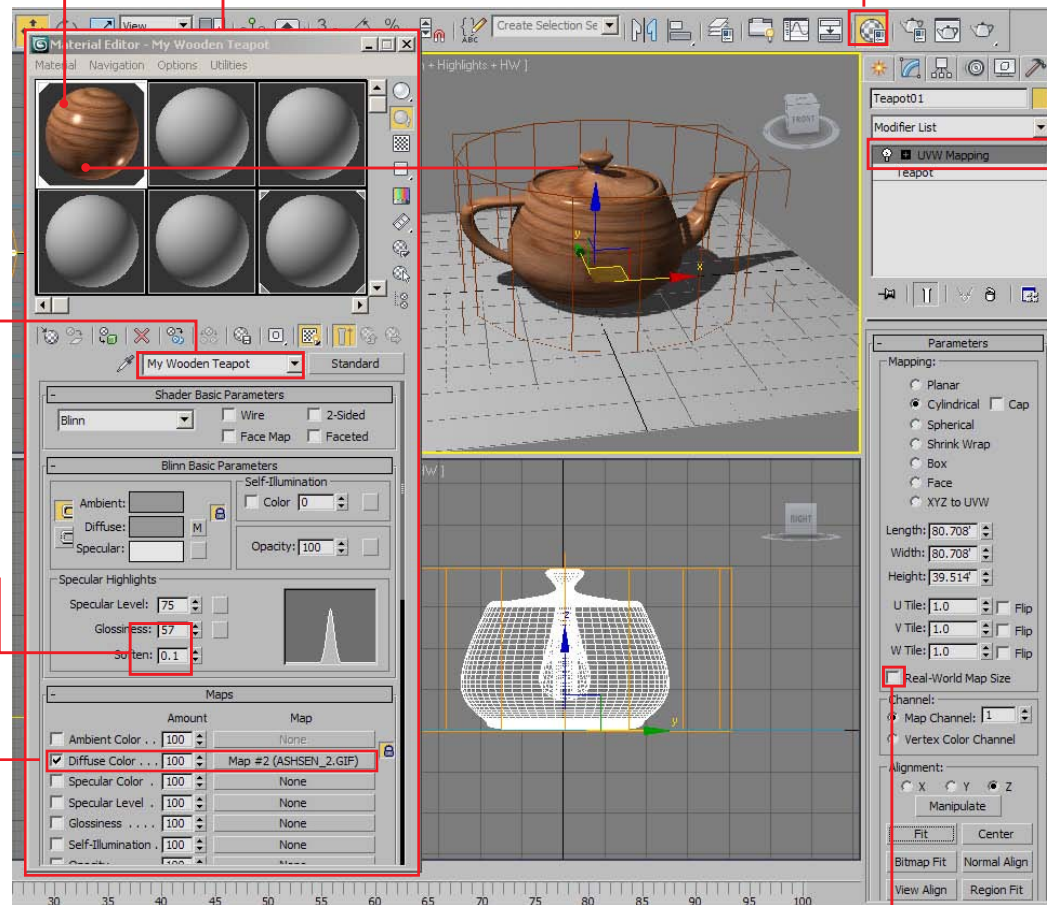

NOTE: On our system, you can find a whole library of JPEG textures on the 'I' Drive.

Or, you can go to www.cgtextures.com and find a large library.

Make sure the Real World Map is turned off.

Animation

Just about everything in 3D Max is animatable. You can animate models, lights and cameras. You can animate the texture/color on an object: animate the color of the lighting in a scene. Below are a few simple steps to get you started.

In this animation, you'll move a teapot over to a heating element (cylinder), then stretch the teapot as if it suddenly reacted to the heat from the hot element.

1. First, make a flat cylinder in the middle of the perspective view. Next, make a teapot. Move the teapot off to the side of the cylinder.

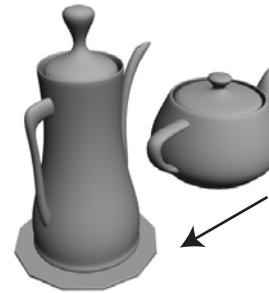

2. Then make sure all "Key Filters" are turned on. This will ensure that the stretching starts when we want it to start and not at the beginning.
3. Turn on the "Auto Key". It and the Timeline will turn red. In this mode, anything you move will be recorded as animation.

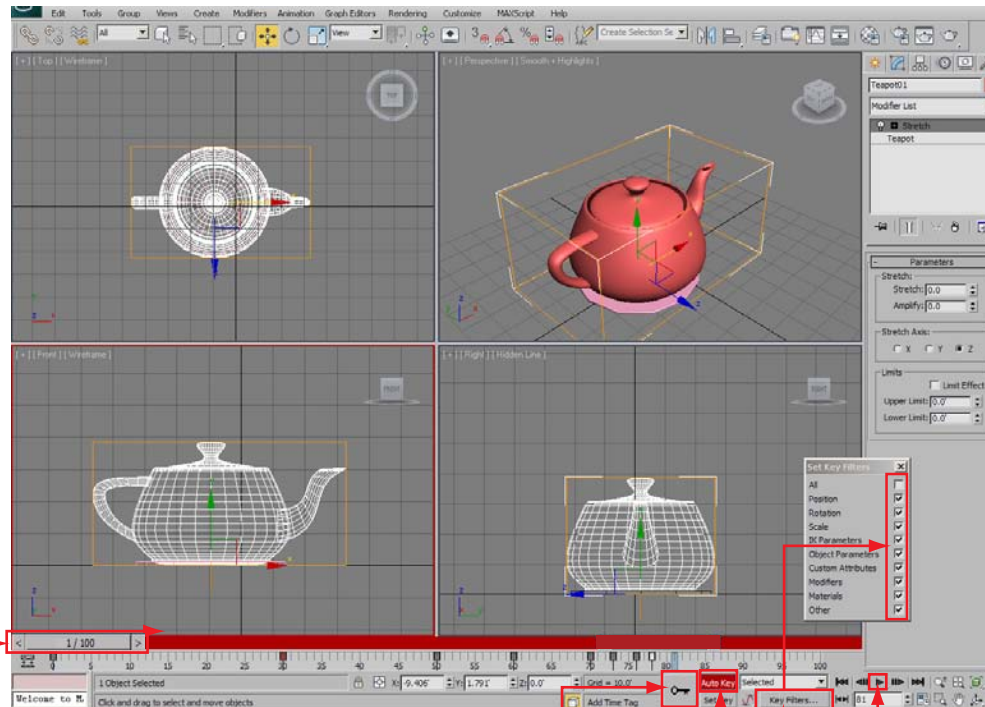

4. Slide the "Scrubber" to frame 1.
5. Move the Teapot onto the cylinder and then move the Scrubber to frame 30. Note the 'Key Frame' appear on the Timeline
6. Add the "Stretch" modifier to the Teapot stack.
7. Move the Scrubber to frame 50 and click the "Make Key" button
8. Move the Scrubber to frame 60 and increase the "Stretch" to 1.0
9. Continue to decrease and then increase the Stretch parameters, while moving the Scrubber. Try to achieve a comic like bounce effect.
10. Click the "Play" button.

Biped

Biped is 3D Max's pre-made character animation rig. All you need to do is size it to your character's proportions and link using the "Skin" modifier.

TIP: Use a character model that has a slender quality. Slender figures are easier to attach to the Biped than are heavy.

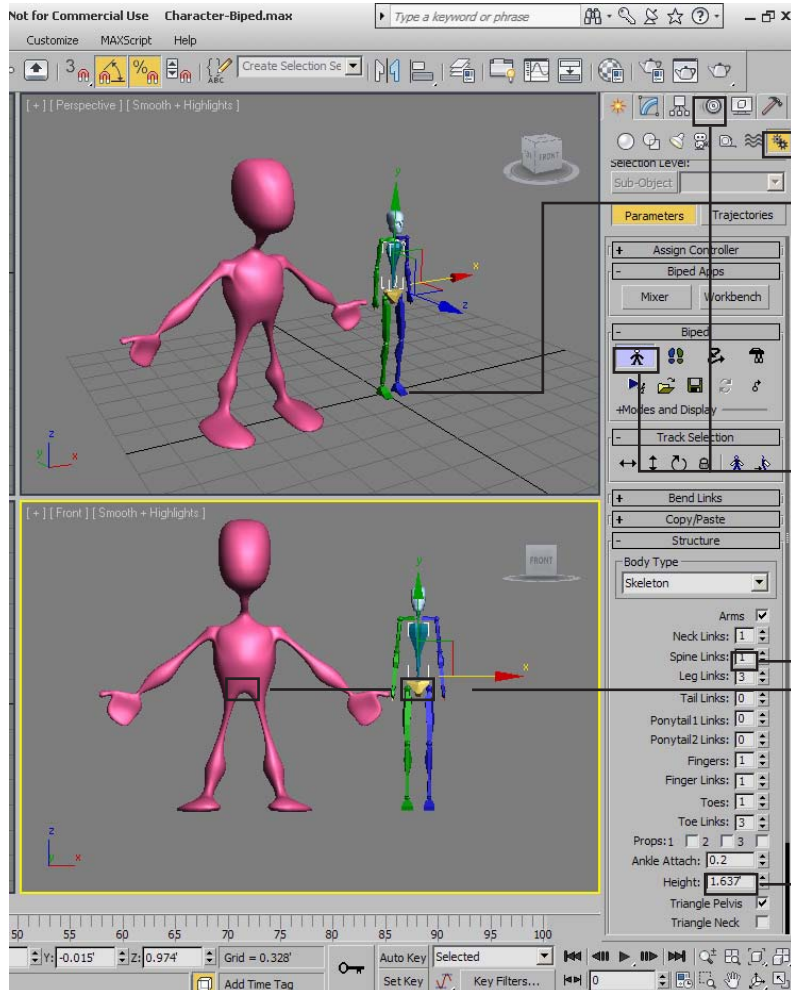

1. The Biped is found under the "Systems" panel.

2. Click and drag the Biped in the "perspective" viewport. Make sure you do it from the very center of the grid.

3. Make the height of the "Pelvic" bone on the Biped match that of your character.

4. Adjust the Biped in the "Motion" panel in "Figure Mode":

- a. Set Spine links to 1
- b. Adjust height, if needed, to match pelvic bones.

5. Move your character over to the Biped.

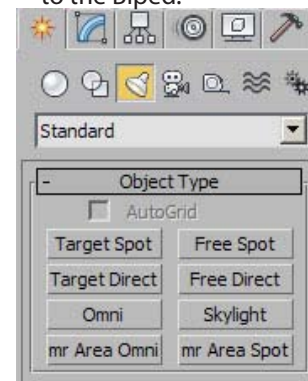

6. Now you will adjust the Biped bones to match the shape of your character.



To "move" a Biped bone, use the move tool and set the coordinate system to "View".



To "Scale" or "Rotate" a Biped bone, use the scale and rotate tools and set the coordinate system to "Local".



Adjust the bones in the side view as well.

Biped

continued

Next, you will apply the "Skin" modifier to your character (Not to the Biped!). The skin modifier links the your character to the Biped.

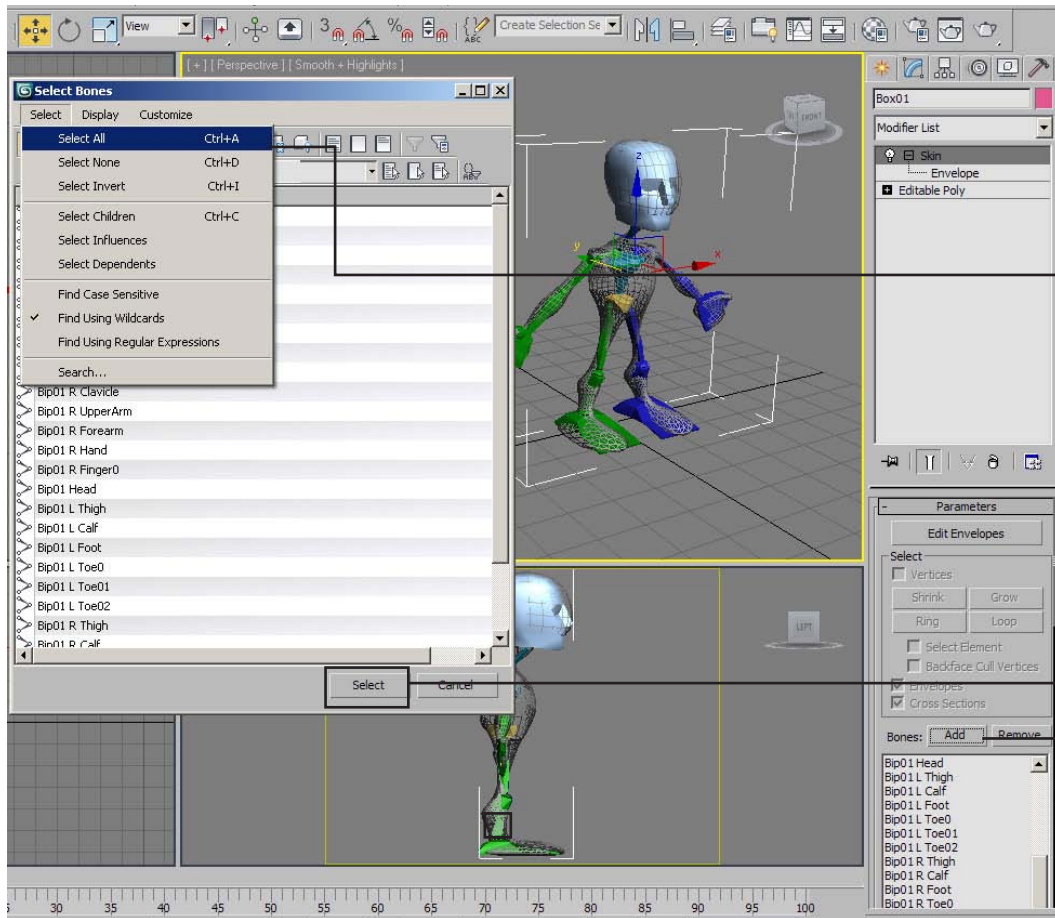

1. The "Skin" modifier is on the modifier list.
2. Place the modifier and click on "Add" Bones.
3. Select "all the bones except the COM (Cneter of Mass) and click select.

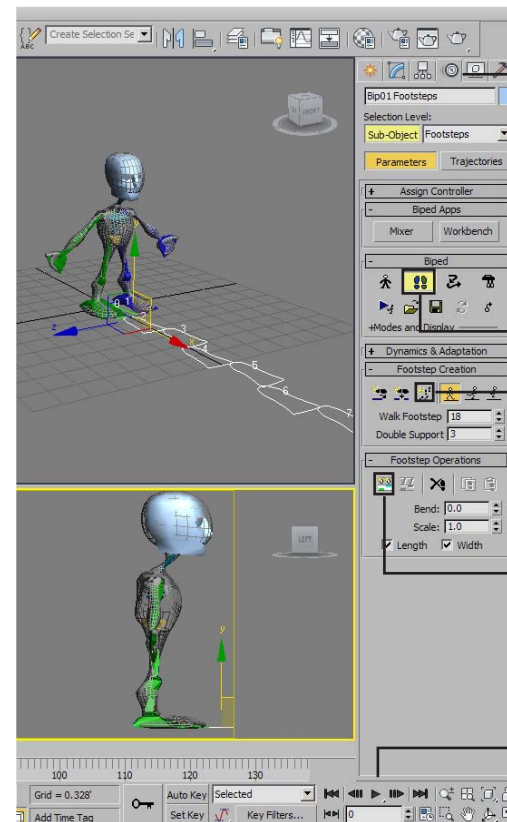

4. Select the Biped and return the to "Motion" panel.
5. Click "Foot Step" mode.
6. Click make "Foot Steps" and set to 10.
7. Click the "Create Keys" button.
8. Click the "Play" button.

Biped

continued

If your character distorts when it moves, then you need to adjust the envelopes. This can be a tricky task, but with patience, you can succeed.

Envelope

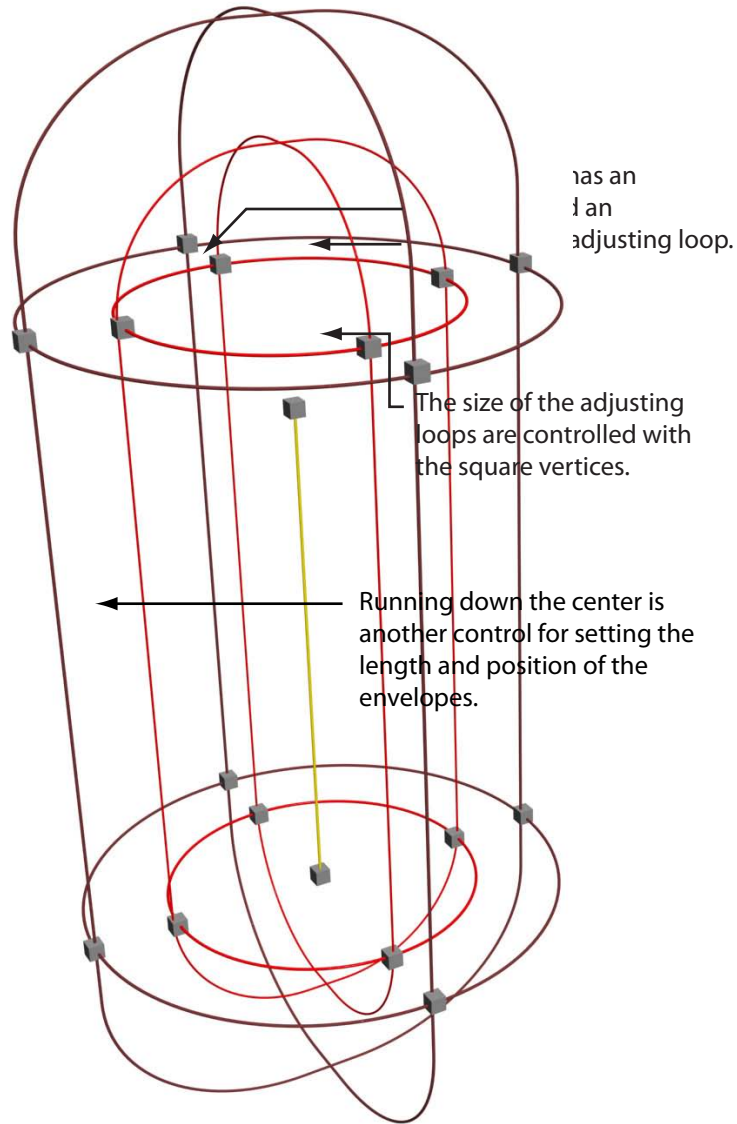

Click and move the vertices.
The degree of envelope influence on the character mesh is indicated by color

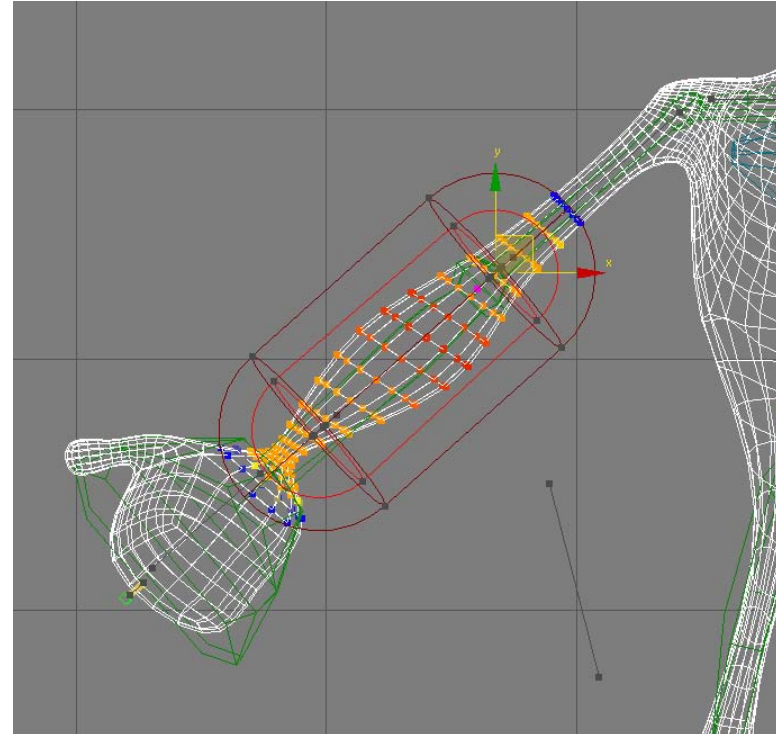

3D Vocabulary

General Terms

Geometry - A 3D object comprised of polygons.

Shapes - A 2D object comprised of segments

Modifier - An attachment to 2D or 3D object designed to alter it in some manner

Parameters - Adjustable settings

Objects - Geometry, Shapes, Lights, Cameras etc.

Viewports - Windows in 3D Max where objects can be manipulated.

Transform - To move, rotate or rescale using the transform tools.

Clone - To duplicate an object.

Material Terms

Texture - The surface quality of a 3D model.

Bump Map - A map that makes a surface look bumpy.

Displacement Map - A map that changes the geometry of a 3D object.

Standard Texture - A simple texturing system.

Raytrace Texture - A complex texturing system that allows for realistic reflections and transparency.

Arch and Design - A complex texturing system that allows for realistic reflections and transparency.

UVW Map - A modifier that instructs 3D Max how to wrap a texture around a 3D model.

Modeling Terms

Box Modeling - Modeling geometry at the sub-object level.

Edit Poly - The modifier applied to geometry for box modeling.

Lathing - Turning a spline around a central axis.

Lofting - Stretching a shape(s) along a complex path.

Extruding - Stretching a shape along a simple path.

ProBoolean Subtraction - Subtracting one mesh by using another

Vertex - The smallest part of geometry or shape.

Edges - Two vertices that are connected make an edge.

Polygon - Three or more edges connected make a polygon.

Hi Poly Model - A model made with many polygons.

Low Poly Model - A model made with few polygons.

Animation Terms

Timeline - The bar at the bottom of the 3D Max interface.

Scrubber - The toggle on the timeline that you can slide right or left to show animation.

KeyFrame - A frame that defines the starting and ending points of a smooth transition.

Curve Editor - The 3D Max panel that allows for manipulation of animation.

Rendering Terms

Render - To turn a 3D scene into a JPEG, QuickTime Movie or other end product.

Active Time Segment - The number of frames to be rendered.

Output Size - The proportions and pixel settings of the rendering.

Scanline - The default renderer for 3D Max.

Mental Ray - An optional, higher quality renderer.